

CYRIS *flow*

The ultimate multisensor
cell analysis platform



ONE DEVICE, MANY ADVANTAGES

Automatic climatisation
(temperature, gas atmosphere
and humidity) of the
measurement environment

Investigation of up to 24 different
treatable cell samples or references
in parallel

Automated detection of
multiple cellular key parameters

Automatic supply of culture
media and addition plus washout
of active substances

Easy to clean and disinfect

Full label-free real-time
measurement for days or weeks

Freely programmable sequences of
experiments and output of the raw and
processed data

Highly reliable industrial computer
and control electronics with
custom designed power supply

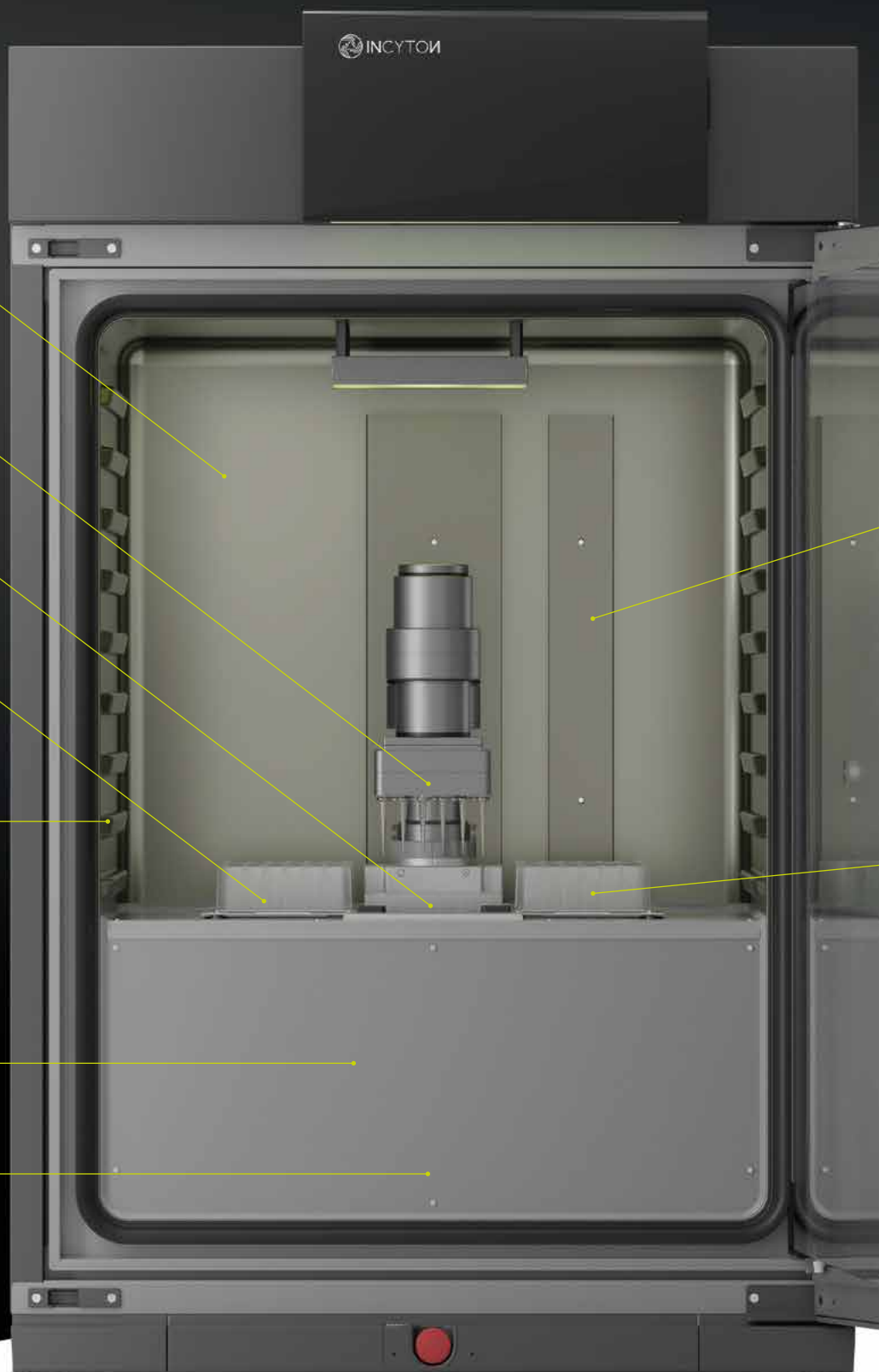

CYRIS® FLOX

– cell analysis at its finest

The multisensor cell analysis platform by INCYTOIN® monitors and analyses different cellular key parameters simultaneously, in real time and label free.

As known, important parameters for representing cell viability are the changes in metabolism and morphology. CYRIS® FLOX constantly monitors, on the one hand,

the metabolism by measuring the cellular oxygen consumption rate (OCR) and the extracellular acidification rate (ECAR) and, on the other hand, the morphology by measuring cellular impedance and microscopic imaging. These measurements are performed automatically in a fully controllable atmospheric environment.

CYRIS® FLOX technology enables the continuous observation of multiple data:

- cellular impedance (magnitude and phase) and microscopic imaging
- dissolved oxygen
- OCR
- pH
- ECAR

Automatic disposal of exhausted media, pooled or retraceable to samples (subsequent investigation possible)



ERGONOMICS AND FUNCTIONAL DESIGN ON YOUR WORKSPACE



USB Ports



ON/OFF
Button

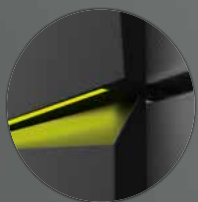

Status light

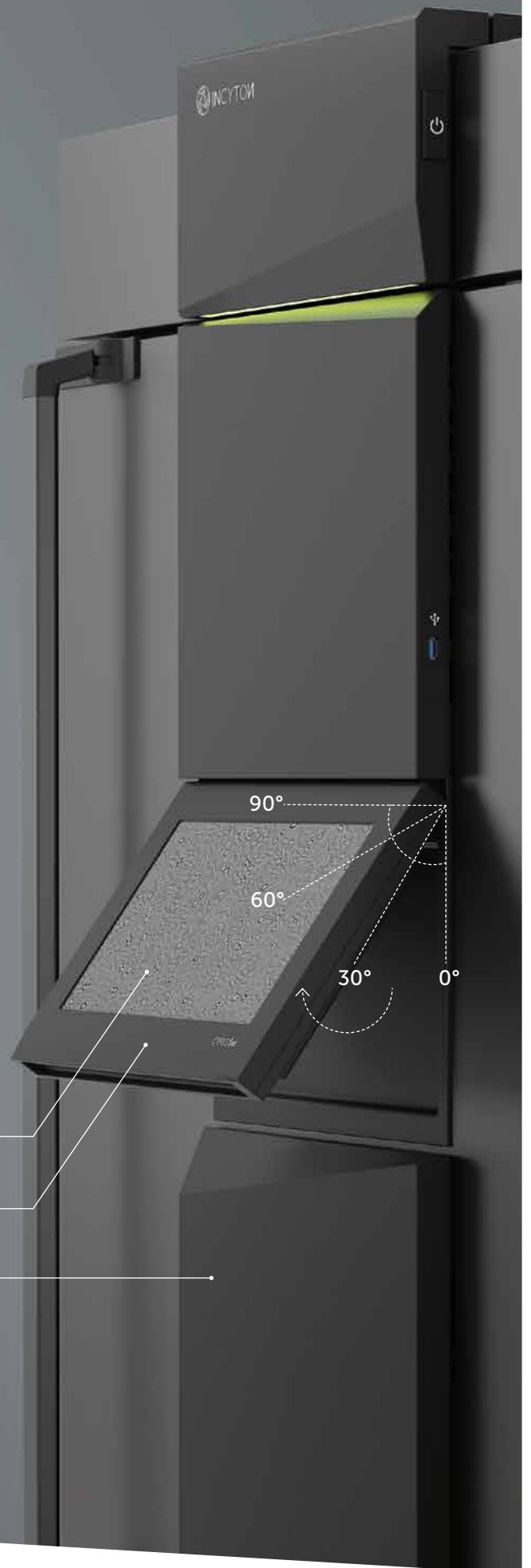

90°

60°

30°

0°

Easy-to-use
user interface

Excellent ergonomics
thanks to the tilted
touchscreen display

Elegant and
functional design

LET'S WALK AWAY!

There is no need anymore to postpone the start of a complex assay because nobody can manage it.

The automated technology by INCYTOI® cares for your cells, treats your samples, and monitors all cellular events while you are away.

Come back any time, your results are waiting for you!



RESEARCH AREAS



Toxicology



Metabolic
research



Oncology



Drug
screening



Basic cellular research



Hypoxia
research

THE APPLICATIONS

INCYTOI® technologies are applicable to various fields, including toxicological assessments, oncology, metabolic profiling, and drug screening, as well as cellular research in general. Our assays help to understand complex cellular relationships through the simultaneous observation of several key cell parameters. In combination with real-time monitoring, the kinetics of substance responses can be identified.

MITOCHONDRIAL STRESS TEST

This test is utilized to create a kinetic profile of key parameters of mitochondrial functions by measuring the OCR of cells under the influence of different inhibitors and uncouplers. Thereby, the basal respiration, ATP production, proton leakage, maximal respiration, reserve capacity, and non-mitochondrial respiration can be defined.

Below is shown the procedure of the CYRIS® analysis platform, with the mouse fibroblast cell line L929 as an example.

The results show that all OCRs measured were evaluable and consistent. The controls show a normal course, and all values have only a small standard deviation. By using this assay, you can gain insight into the usable oxygen levels for ATP production and define the maximum respiration of your cell line, besides obtaining valuable information on basal respiration, reserve capacity and non-mitochondrial oxygen consumption at the same time.

FCCP Concentration

- Control
- 0.25µM
- 0.50µM
- 0.13µM

n=6 for FCCP treated

Temporal course of the OCR while L929 cells undergo a standard Mitochondrial Stress Test. All key parameters of mitochondrial function can be evaluated.

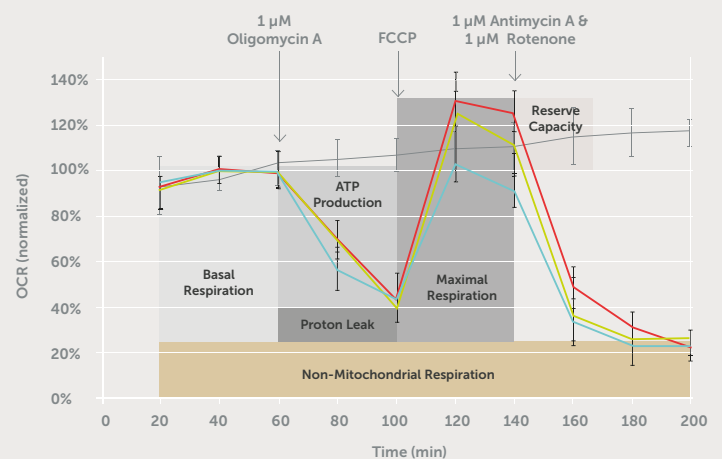

TOXICOLOGY

This assay demonstrates the power of a combined real-time sensor system and a microscope. L929 mouse fibroblast cells were investigated in the CYRIS® analysis platform under the influence of the reference toxicant sodium lauryl sulfate (SLS). The test settings included 12 h of pretreatment and 12 h of treatment with different concentrations of SLS. Throughout the assay, OCR and ECAR, as well as morphology based on regular microscope images, were recorded.

The results of the metabolic monitoring clearly show the concentration-dependent change in cellular OCR and ECAR in a quantitative and temporal profile. The medium SLS concentration (77.8 µg/ml) demonstrates how multiple sensing devices can identify the temporal mechanisms of the action of a substance. In the first 3 h after SLS addition, the OCR is reduced, while ECAR increases.

Responsible for these opposite effects are rapidly occurring damages to the mitochondrial membranes and the attempt of the cell to compensate for this by increased glycolysis. After continuation of the treatment, the damage to all the cell membranes finally leads to cell death and a drop in all the metabolic values.

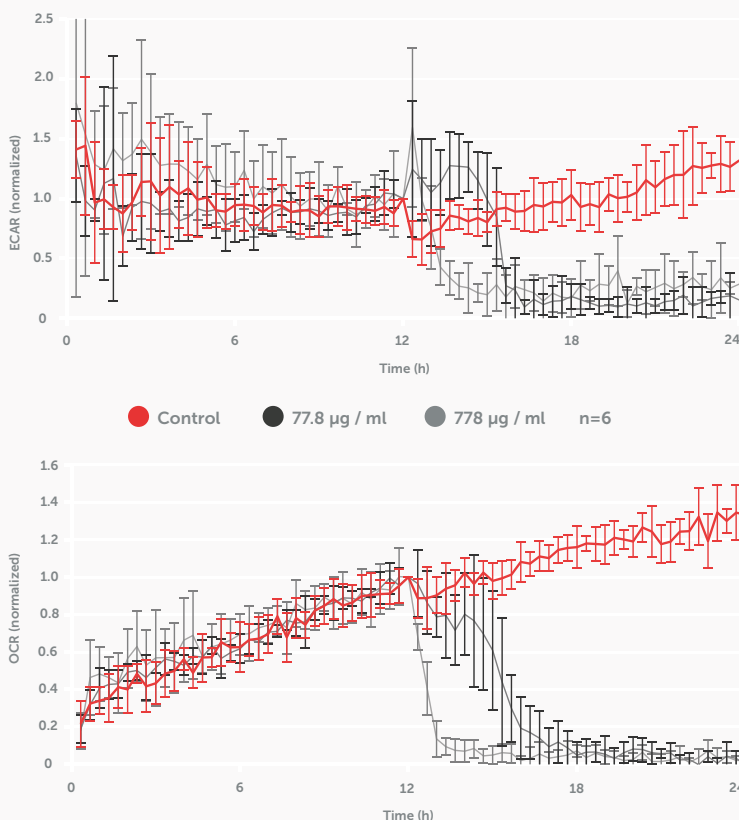

OCR and ECAR of L929 cells under treatment with different concentrations of SLS (0 µg/ml, 77.8 µg/ml, 778 µg/ml) show a clear dose- and time-dependent reaction. After the initial impairment of the respiratory chain, at first the cells try to compensate for this loss by higher glycolytic activity (ECAR).

CORRELATION OF SENSOR DATA

Because the exact time points of every measuring and imaging event are known, it is possible to correlate these data for comparison. Clear correlations are visible by comparing the OCR with the hourly recorded microscopic images of the cells.

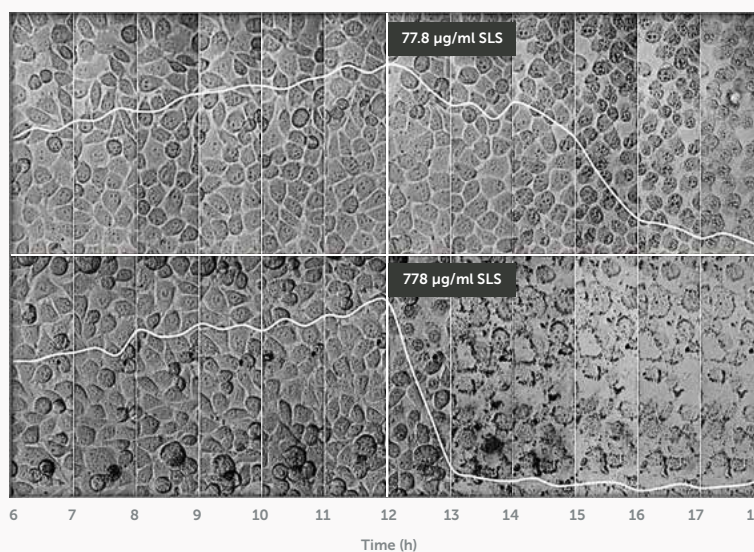

CYRIS® FLOX

The comprehensive multisensor cell analysis platform, with label-free, high-accuracy and high-reliability monitoring

HOW IT WORKS

During the measurement, living adherent cells are cultivated and treated in the 24 independent test chambers of a special sensor-equipped microtiter plate (sensor plate), located in a temperature- and atmosphere- controlled climatic chamber.

A fully automated pipetting robot supplies and disposes of media and drugs in all 24 test chambers. This life support fluidic system allows the cells to be monitored and treated in the sensor plate for days up to several weeks in vital conditions and free of disturbance and contamination.

All measurements and treatment protocols in the sensor plate are individually configurable and are monitored online and in real time.

20x objective with ultra-fast and high precision focusing



24 channel pipetting head



24 well sensor plate

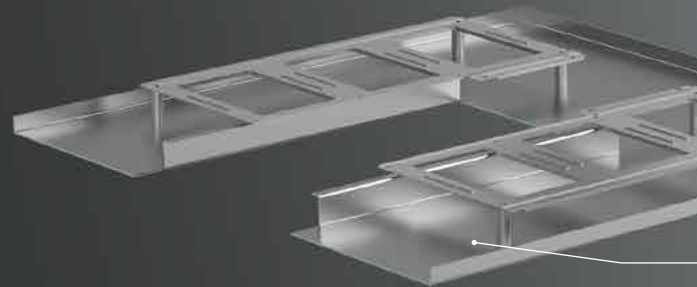
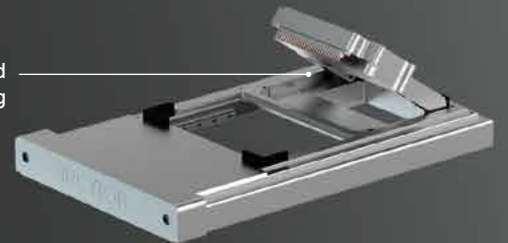
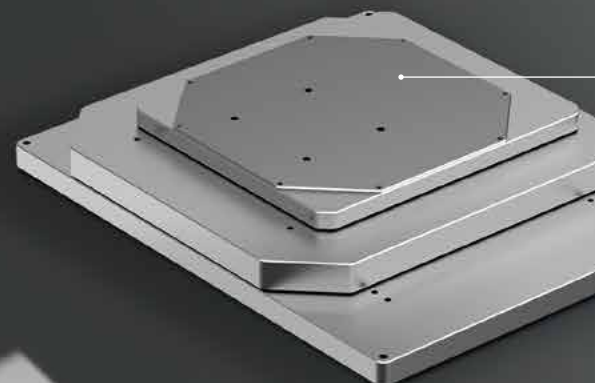

Plate slot and impedance housing



Microscope



Highly compact SCARA robotic arm with 4 degrees of freedom for accurate pipetting

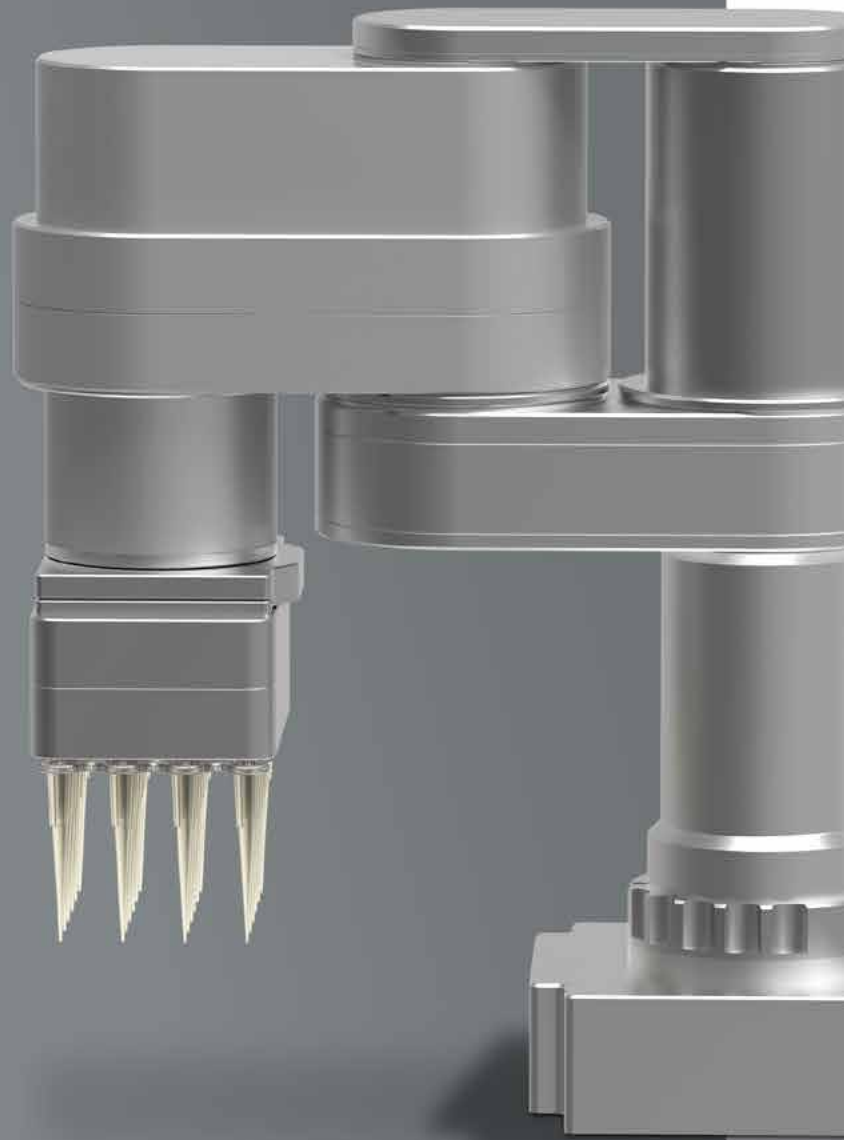

Reservoir

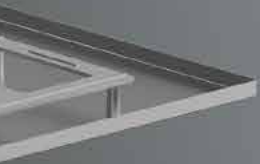

Stainless steel work area

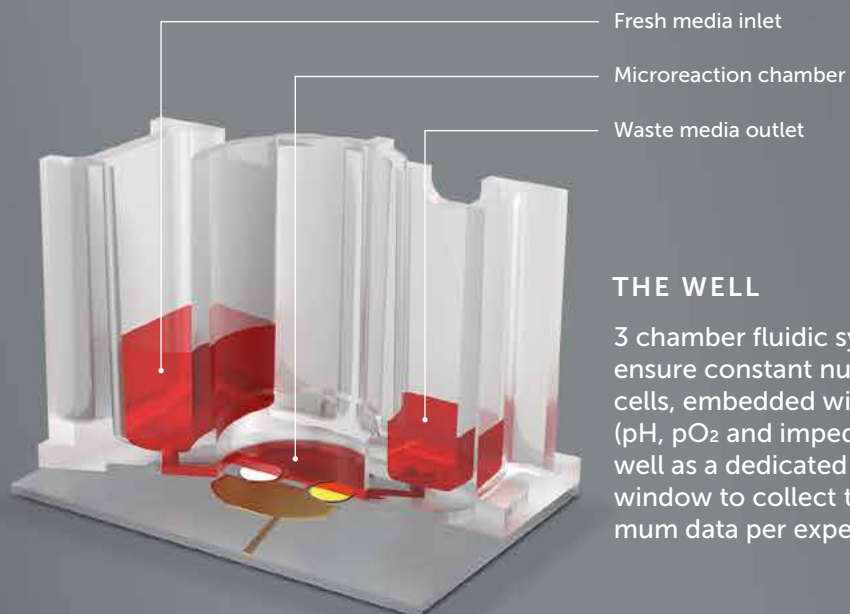

Fresh media inlet

Microreaction chamber

Waste media outlet

THE WELL

3 chamber fluidic system to ensure constant nutrition for cells, embedded with 3 sensors (pH, pO₂ and impedance) as well as a dedicated microscopy window to collect the maximum data per experiment

XY-Stage



PHARMACOLOGICAL COOPERATION

If you are a pharmaceutical company, visit our website to know more about how our technology can help you bringing your drugs and vaccines to market.

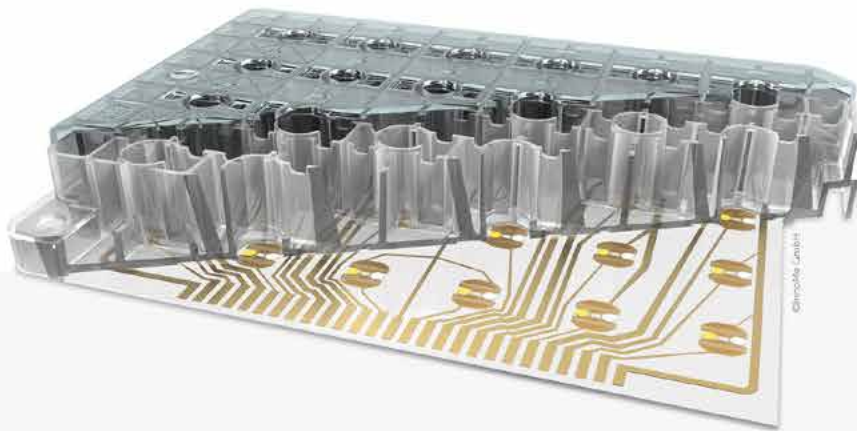

CONSUMABLES

We can provide you with three different types of sensor plates

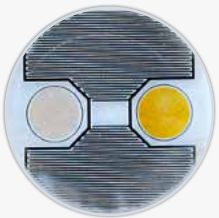

Zylar® Plate Corpus and Volume Reduction Cover

Optochemical sensors for pO₂ and pH measurement

Gold IDEs Structure on glass surface for cellular impedance analysis

Dedicated microscopy window

Highest data output

Number of wells: 24
Available in packages of 6 pcs



Zylar® Plate Corpus and Volume Reduction Cover

Optochemical sensors for pO₂ and pH measurement

Plasmatinized foil for optimal cell growth

For high-throughput screening with on the fly ECAR and OCR measurement

Number of wells: 24
Available in packages of 6 pcs



Zylar® Plate Corpus and Volume Reduction Cover

Free microscopy on any point of the microwell chamber

Number of wells: 24
Available in packages of 6 pcs

Write us at sales@incyton.com or fill in the form at www.incyton.com/contact-us for further information and quotes or to arrange a meeting



TECHNICAL DETAILS

General technical data

Dimensions (W/H/D)	mm	760 x 1230 x 730
Weight	kg	230
Electrical supply	VAC / Hz	230 ± 10 / 50-60

Environmental conditions for storage and operation

Temperature range	°C	5 - 40
Relative humidity, maximum	% rH	80

Incubator

Setting temperature range	°C	+18 to +50
Setting temperature step	°C	0.1
Setting relative humidity range	% rH	30 - 90
Setting O2 range	%	1 - 21

Robot

Pipetting volume	µl	5 - 200
Amount of channels / tips	-	24

Microscope imaging system

Objective magnification	x	20
Z – drive type	-	VoiceCoil
Focus range / resolution	µm	6800 / 0.002
Camera resolution	MPx	12.3
Pixel size	µm	3.45

Cellular impedance

Throughput (wells per second)	1 / s	14
Measuring frequency	kHz	10
Measuring range impedance Z	Ω	10 - 5000
Measuring range resistance R	Ω	10 - 5000
Measuring range capacity C	nF	0.3 - 3000
Measuring error	%	< 2

pH and pO₂ single channel measuring device

	pO ₂	pH
Measuring range	0 - 50 %	6.0 – 8.5 pH
Resolution	± 0.4 % pO ₂	± 0.05 pH
Signal drift	0.2 % / week	0.1 pH / week
Accurateness	± 1.0 % at 20.9 % pO ₂	± 0.2 % at pH7

CYRIS® ACE - Software Specifications

Applications	Create & analyse assay result files
Operating Systems	Windows 7 and above

Imagine how you could
spend your walk-away time.
Contact us today, we would
love to hear from you.



CONTACT

CYRIS® FLOX – The complete solution to high-quality cell-based analysis

EUROPE
Headquarters in Germany

info@incyton.com
P: 0049 (0)89 / 203 241 42 71

CHINA
Beijing Huawei Zhongyi Technology Co. Ltd
Huawei International (HK) Limited

Room 506, Unit 3, Building 4, No. 6,
Auto Museum East Rd, Fengtai District,
Beijing, P.R. China

P: +86-10-83659327
huawei@hwsci.com

FOR RESEARCH USE ONLY.
NOT FOR THERAPEUTIC OR DIAGNOSTIC USE

Published in 2020 by:

Incyton GmbH
Am Klopferspitz 19a
82152 Planegg (Munich) – Germany
www.incyton.com

© All rights reserved.